

Ceiling Mount: 1:8 Scale

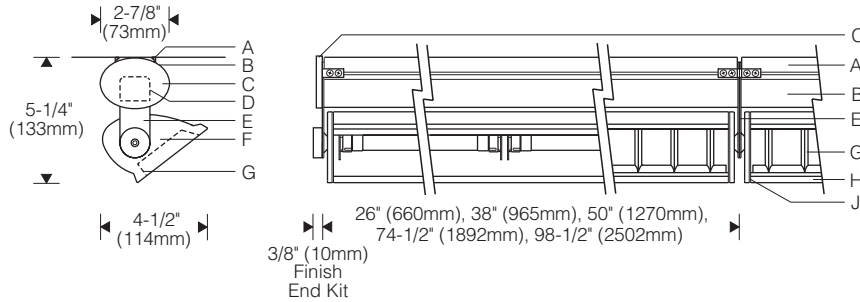

Mounting Plate (S mount)

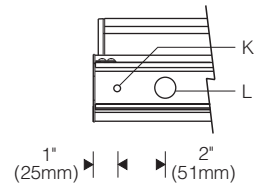

Installation (S mount)

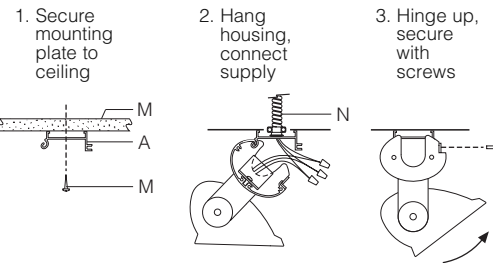

Hangers (X mount) Pendant Stems

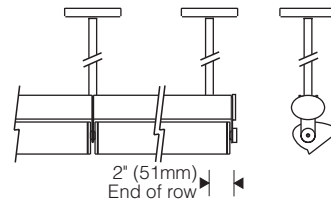

Cables

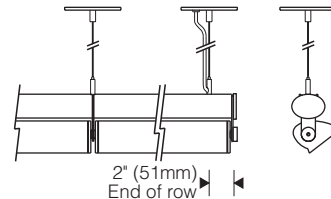

Cantilevers

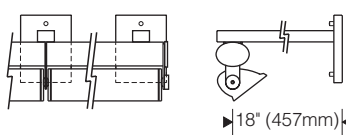

Specifications

A Extruded aluminum mounting plate	D Electronic ballast	H Specular extruded aluminum reflector	L Knockout, (2) 7/8" (22mm) dia.
B Extruded aluminum ballast housing	E Aluminum sidearm	J Aluminum reveal plate (black)	M Support structure and fasteners (by others)
C AFE finish end kit (aluminum end plates and knobs)	F Die-cast aluminum end plate	K Mounting hole, (3) 9/32" (7mm) dia.	N Conduit and connector (by others)
	G Snap-in specular parabolic baffle (optional)		

Finish:

Style 105 fluted – bright clear anodized aluminum housing. Painted end plates, sidearms and ballast housing in choice of silver or semi-gloss black.
Style 106 smooth – semi-gloss white housing and end plates. Painted surfaces – 6 stage pretreatment and electrostatically applied thermoset powder coat for stable, long lasting and corrosion resistant finish.
 Reflector – extruded high purity aluminum with clear anodized specular finish. All luminaire hardware – stainless steel.

Mounting:

S mount – mounting plate fastens flush to ceiling. Unit hinges on plate for hands-free access to wiring.
X mount – stems, cables or cantilevers **ordered separately**.
 Pendant stem – 11/16" O.D. aluminum, internally threaded.
 Cable – 1/16" dia. 7x7 aircraft cable, field adjustable length.
 Cantilever – 1" x 2" steel arm. Interface plate (under canopy) allows ±5° leveling, **suitable support structure required**.

Electrical:

Use 90°C wire for supply connections and through wire.
S mount – 7/8" (22mm) dia. knockouts at ends of mounting plate for conduit feed (by others). Accessory end feed kit provides entry for surface conduit at end of ballast housing.
X mount – electrical feed hanger mounts over recessed outlet box (by others) and **must be located at end of row**.
 Housing hinges down for access to ballast and wiring. Optional #12 AWG prewired modular through wiring with quick connectors.
 Integral electronic HPF thermally protected class P ballast. Optional electronic dimming ballast dims to 5% of full light output. Compatible dimmer switch is required (by others). Consult local sales representative for specifications.
 Optional integral emergency battery operates one lamp. Separate unswitched supply is required.
Standard:
 UL listed or CSA certified.

Features

- Unequalled T8 wall wash – ideal for office and retail perimeters, displays, art walls, marker boards, corridors
- Adjustable – accommodates setback and height of wall
- Versatile – surface, cantilever, stem or cable mounting
- Integral electronic ballast – dimming, emergency optional
- Optional parabolic cross baffle for lengthwise shielding

Performance

Two parabolic reflector sections drive light to the bottom of the wall. An elliptical section shields the lamp from normal viewing angles and redirects its light to a parabola. Glare is minimized and asymmetry of the beam is maximized resulting in high beam efficiency and superior surface uniformity.

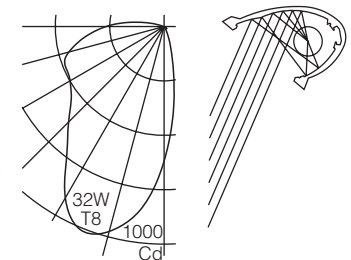

For complete photometrics, visit thelightingquotient.com



To form a Catalog Number



1 Source

F = Linear fluorescent

2 Style

105 = Small fluted surface, integral ballast
 106 = Small smooth surface, integral ballast

3 Lamp

A | | | | = T8 Fluorescent Lamp Code

Lamp Wattage (see chart below)

Number of Lamps in Length, specify 1 or 2

Example: **A225** = one nominal 6' reflector with two 25W T8 lamps; one 2-lamp ballast

Lamp Code	Luminaire Length*	Lamp(s)
T8 Fluorescent		
A117	26" (661mm)	1 x F17T8
A125	38" (966mm)	1 x F25T8
A132	50" (1270mm)	1 x F32T8
A225	74-1/2" (1893mm)	2 x F25T8
A232	98-1/2" (2502mm)	2 x F32T8

For complete lamp and ballast information, see Accessories Section. T8 lamp not included.

* Add 3/4" (19mm) to row or single unit for **AFE** Finish End Kit.

4 Mounting

S = Ceiling (surface) mount
 X = For use with pendant stem, cable or cantilever hangers (order separately)

5 Finish

Style 105 Fluted
 Bright clear anodized reflector with painted components in choice of:

01 = Silver
 81 = Semi-gloss black

Style 106 Smooth

02 = Semi-gloss white

99 = Custom RAL or computer matched color to be specified, consult sales representative

Project: _____

6 Voltage/Ballast

Electronic Dimming
 1 = 120V T = 120V
 2 = 277V V = 277V
 3 = 347V (Canada)

Note: When dimming X mount luminaires, order two (2) electrical feed stems, cables or cantilevers for each single unit or row to accommodate the control circuit.

7 Option (see Accessories Section for specifications)

- 00 = No option
- 0B = Snap-in parabolic cross baffles, specular aluminum, provides 35° lengthwise shielding
- 0E = Integral emergency battery pack with indicator lamp and test button (not available for **A117** lamp code). Operates one lamp. Note: For X mount, order one additional electrical feed stem, cable or cantilever to accommodate unswitched feed to battery.
- 0K = Prewired modular #12 AWG through wiring with quick connectors
- 0EK = Combination of emergency battery pack and prewired modular through wiring as described above
- 0BE = Combination of parabolic baffle and emergency battery
- 0BK = Combination of parabolic baffle and modular wiring
- 0BC = Combination of parabolic baffle, emergency battery and modular wiring
- 0XX = For modification not listed, include detailed description. Consult factory prior to specification.

8 Destination Requirement

- 0 = UL listed or CSA certified for U.S.
- J = UL listed or CSA certified for Canada

Example

F105 - A225 - S - 81 - 1 - 0B0

Small fluted surface model for use with two 3' F25T8 lamps, 74-1/2" long housing (not including **AFE** finish end kit, order separately). Ceiling mounted. Bright reflector with semi-gloss black end plates, side arms and ballast housing. Integral 120V electronic ballast. Snap-in parabolic cross baffle. UL listed or CSA certified for U.S.

Type: _____

Hangers

Order separately. See Accessories Section for specifications. Singles – order one non-electrical and one electrical feed hanger for each module (X mount).

Rows – order one non-electrical hanger for each module (X mount) plus one electrical feed for each row.

Note: For each single or row with dimming (voltage/ballast code T or V) or for each module with emergency battery (option code 0E), order one additional electrical feed and subtract one non-electrical hanger.

Electrical feed(s) must be located at an end of row.

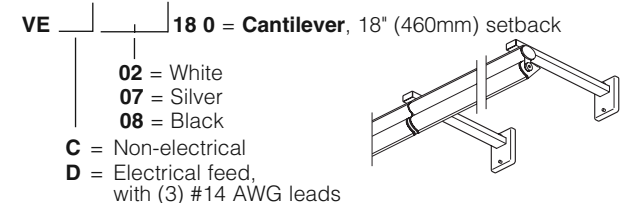
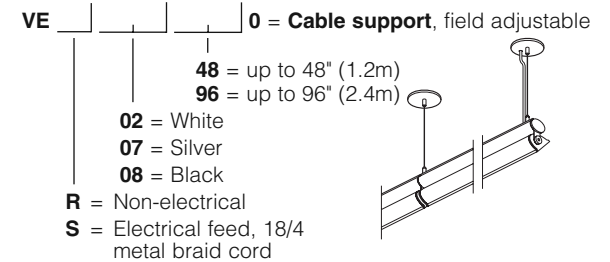
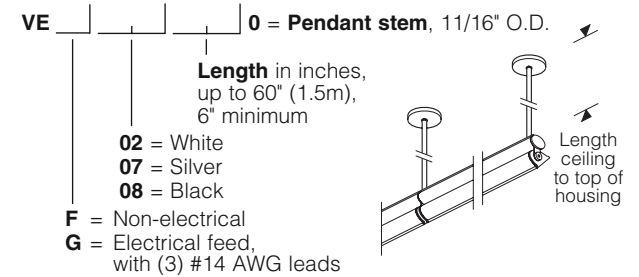

Accessories

Order separately. See Accessories Section for specifications.

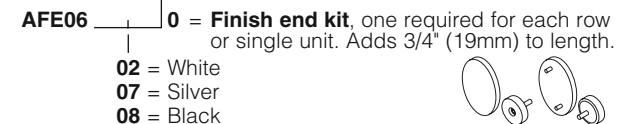

ASC06000 = End feed kit, bracket with 7/8" dia. entry to secure surface conduit

Certain products illustrated may be covered by applicable patents and patents pending. These specifications supersede all prior publications and are subject to change without notice. Copyright © 2011 Sylvan R. Shemitz Designs, Inc., all rights reserved.