

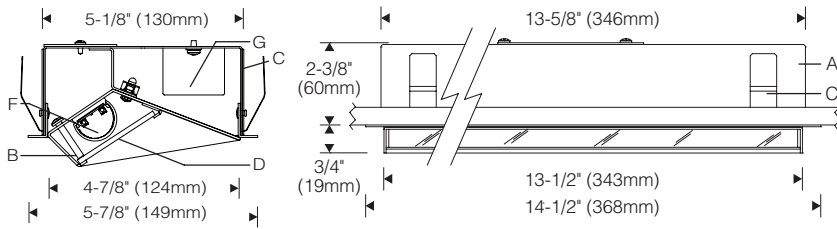

**T Mount: Non-accessible Ceiling** 1:8 Scale

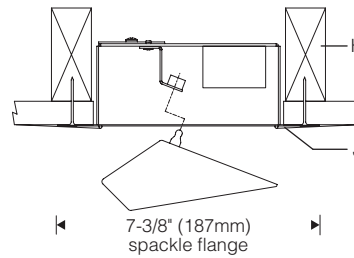

**P Mount: Non-accessible Ceiling** 1:8 Scale



**L Mount: Accessible Grid Ceiling** 1:8 Scale

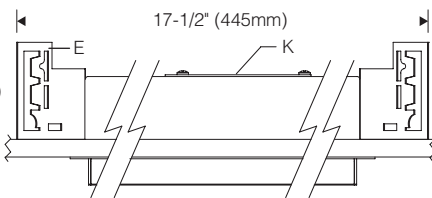
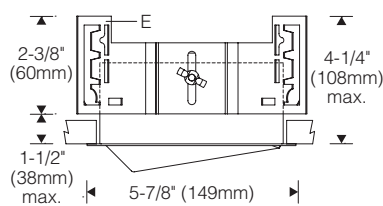

**Rough Opening**

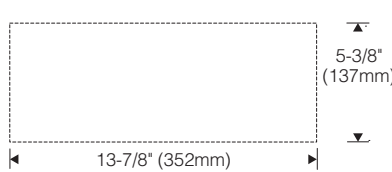

T- and L-mount with overlapping trim



P-mount trimless

**Specifications**

- A** Aluminum back box/ trim frame
- B** Removable aluminum heat sink/housing
- C** Stainless steel mounting springs (4 included)
- D** Acrylic lens with elliptical diffusion
- E** Universal mounting brackets (L mount)
- F** Field serviceable light engine with asymmetric optic
- G** Integral constant current driver
- H** Supplemental framing/support (by others)
- J** Skim coat of plaster
- K** Wiring access plate

**Features**

- Low profile – minimal silhouette focuses attention on the luminous wall, not the luminaire
- Shallow recessed depth – fits under ducts at core walls
- Over 3500 lumens delivered @ only 32W input
- Compatible with lay-in or drywall ceilings



**Optical Assembly:**

Formed aluminum housing, back box and trim frame; stainless steel hardware and spring mounting clips. Extruded aluminum heat sink, Precision extruded polymer refractive lens with optimized asymmetric distribution. Light engine may be removed for service or upgrade. Acrylic lens with elliptical diffusion maximizes lateral distribution without disturbing asymmetric forward throw.

**Finish:**

Housing, back box and trim frame finished in choice of matte or semigloss white. Painted surfaces – 6 stage pretreatment and electrostatically applied thermoset polyester powder coating for a durable abrasion, fade and corrosion resistant finish.

**Electrical:**

Use 90°C wire for supply connections. Integral electronic HPF constant current driver with quick connector. For complete driver specifications, see website, reference document [MA-1303](#). Access plate on top of back box with two 1/2" knockouts for supply wiring. Internal splice compartment allows for access to splices below ceiling.

**Mounting:**

Luminaire installs from below finished ceiling – up to 1-1/2" (38mm) thick.

**T** mount provided with overlapping trim and spring clips for gypsum board/inaccessible ceilings.

**L** mount provided with overlapping trim and adjustable brackets for T-bar grid/accessible ceilings. Supplemental support wires, bar hangers, etc. (by others) required for accessible ceilings.

**P** mount (trimless) provided with perforated spackle flange for gypsum board/inaccessible ceilings. Supplemental framing and/or support required (by others).

Fixture weight: 3.0 lb (1.4 kg).

**Standard:**

CSA Certified for dry locations For damp location specify "0P" option. Suitable for insulated ceilings (Type IC). 5 year warranty, maximum ambient temperature 45°C (113°F)

**Performance**

Precisely extruded acrylic lens produces an asymmetric distribution ideal for illuminating vertical surfaces evenly from top to bottom.

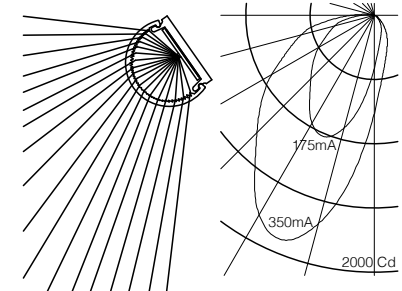

L90(10k) > 60,000 hrs. @ 25°C per TM-21

For LM79 and photometric reports, visit [thelightingquotient.com](http://thelightingquotient.com)





**T Mount: Overlapping Trim** 1:8 Scale

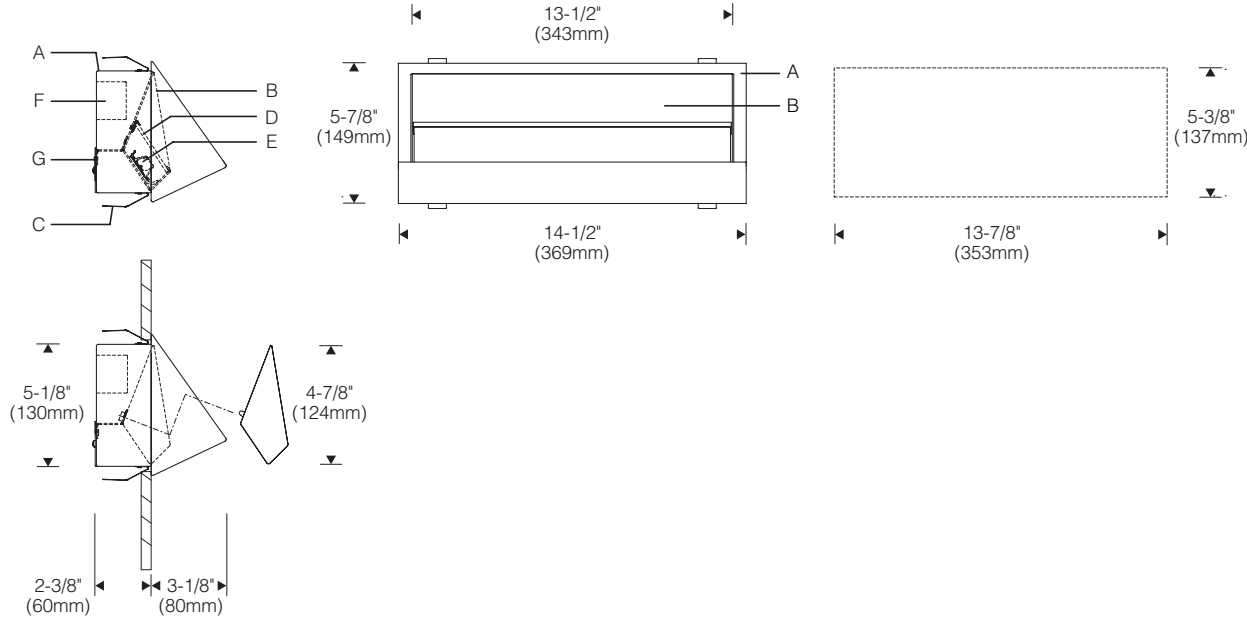

**Rough Opening**

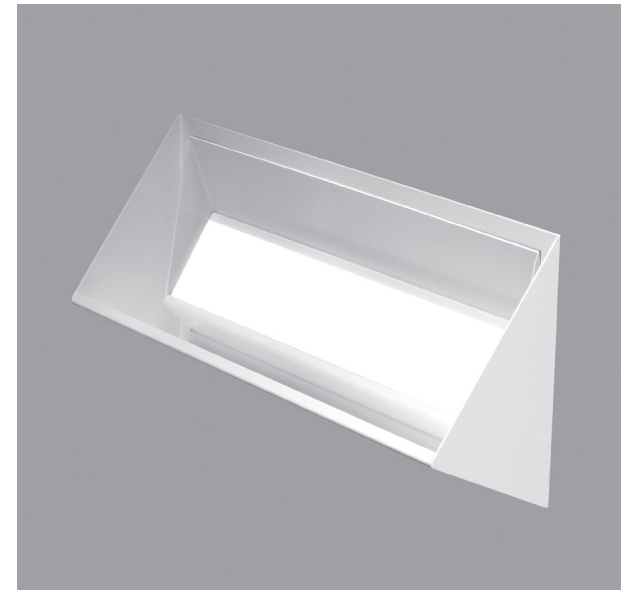
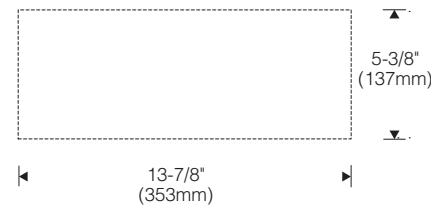

**Specifications**

- A** Aluminum back box/trim frame/cutoff visor
- B** Removable aluminum heat sink/housing
- C** Stainless steel mounting springs (4 included)
- D** Acrylic lens with elliptical diffusion
- E** Field serviceable light engine with asymmetric optic
- F** Integral constant current driver
- G** Wiring access plate

**Optical Assembly:**

Formed aluminum housing, back box and trim frame; stainless steel hardware and spring mounting clips. Extruded aluminum heat sink, Precision extruded polymer refractive lens with optimized asymmetric distribution. Light engine may be removed for service or upgrade. Acrylic lens with elliptical diffusion maximizes lateral distribution without disturbing asymmetric forward throw.

**Finish:**

Housing and back box/trim frame/cutoff visor finished in choice of matte or semigloss white. Painted surfaces – 6 stage pretreatment and electrostatically applied thermoset polyester powder coating for a durable abrasion, fade and corrosion resistant finish.

**Electrical:**

Use 90°C wire for supply connections. Integral electronic HPF constant current driver with quick connector. Access plate on rear of back box with two 1/2" knockouts for supply wiring. Internal splice compartment allows for access to splices behind wall. For complete driver specifications, see website, reference document [MA-1303](#).

**Mounting:**

Luminaire installs from outside finished wall – up to 1-1/2" (38mm) thick.

**T** mount provided with overlapping trim and spring clips. Fixture weight: 3.0 lb (1.4 kg).

**Standard:**

UL listed or CSA certified for dry locations. Suitable for insulated walls (Type IC). 5 year warranty, maximum ambient temperature 45°C (113°F).

**Features**

- Minimalistic silhouette focuses attention on the luminous ceiling, not the luminaire
- Less than 4 inch projection – ADA compliant
- Patented asymmetric optics ensure a uniform ceiling brightness
- Shallow recessed depth (2-3/8") fits into most walls

**Performance**

*fraqtir* technology uses a combination of refraction and total internal reflection, creating a distribution of light ideal for illuminating surfaces uniformly. Glare is minimized while light delivered to the target is maximized, resulting in high application efficiency.

For LM79 and photometric reports, visit [thelightingquotient.com](http://thelightingquotient.com)

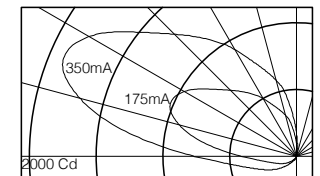

L90(10k) > 60,000 hrs. @ 25°C per TM-21

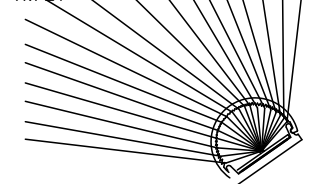

To form a Catalog Number

Project: \_\_\_\_\_ Type: \_\_\_\_\_

**S** | 2 | 2 | 3 | - | - | - | - | - | - | **V** | - | - | - | - | - | - | - | - | - | - |

1        2        3        4        5        6        7        8        9        10

**1 Style**

S223 = Low profile semi-recessed wall washer, integral driver

**2 Output / Power**

S = Standard output  
H = High output

**3 Length**

14 = 14 inch (16W standard, 32W high output)  
See [Scaled Performance Table](#)

**4 Mounting**

T = Overlapping flange with spring clips for gypsum board wall

**5 Finish**

02 = Semigloss white	13 = Matte Black	22 = Matte White
06 = Dark bronze*	15 = Metallic	PL = Platinum
07 = Silver*	17 = Champagne*	99 = Custom or RAL, consult rep.*
08 = Semigloss black	18 = Copper*	

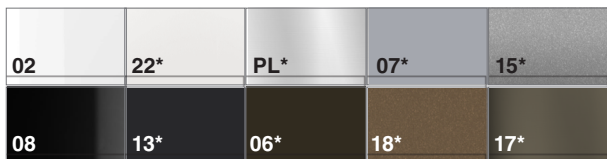

\* = non-cancellable/returnable

**6 Voltage**

M = 120-277V Universal voltage input



**7 Option**

V0 = Visor  
 VM = Visor; for use in MRI medical facility (T mount only). MRI filters required on output of each remote driver. Consult factory prior to specification.  
 XX = For modification not listed, include detailed description. Consult factory prior to specification.

**8 Destination Requirement**

0 = UL listed or CSA certified for U.S.  
 J = UL listed or CSA certified for Canada

**9 Color Temperature / CRI**

927 = 2700K, 90+ CRI      TWH = Tunable White   
 930 = 3000K, 90+ CRI      2700K-6500K 90+CRI  
 935 = 3500K, 90+ CRI      RGB = Color tunable   
 940 = 4000K, 90+ CRI      RGBW with 3500K, 90+ CRI white

Note: Additional CCT and CRI options are available; consult factory.

**10 Dimming**

00 = Non-dimming  
 ZX = 0-10V analog dimming 120-277V or 347V input, dimming 100%-1%, 0-10V controls by others  
 EL = 0-10V eldoLED SOLOdrive, 120-277V input, dimming 100%-0.1%, 0-10V controls by others  
 ED = DALI eldoLED SOLOdrive, 120-277V input, dimming 100%-0.1%, DALI controls by others  
 TD = ERP forward or reverse phase 120V only, dimming 100%-6%, 120V phase controls by others  
 DZ = TWH 2-Channel driver for use with (2) 0-10V controls by others  
 DD = TWH 2-Channel DALI driver (DALI controls by others)  
 DA = RGBW 4-Channel DMX module (DMX controls by others)  
 DM = RGBW 4-Channel eldoLED LINEARdrive (DMX controls by others)

**Controls**

AWB-TP-DMX-0 = RGBW LED dimmer switch fits in a standard wall switch box and provides on/off control as well as fixed levels of dimmability. The dimmer switch has a color-selection wheel for thousands of color options, 10 dynamic color-changing/single color modes, 0-100% dimming, on/off controls, and 4 color-specific channel controls for red, green, blue, and white.



Additional Wired and wireless controls available, see [Driver and Controls Information](#)

