

**V Mount** 1:10 Scale

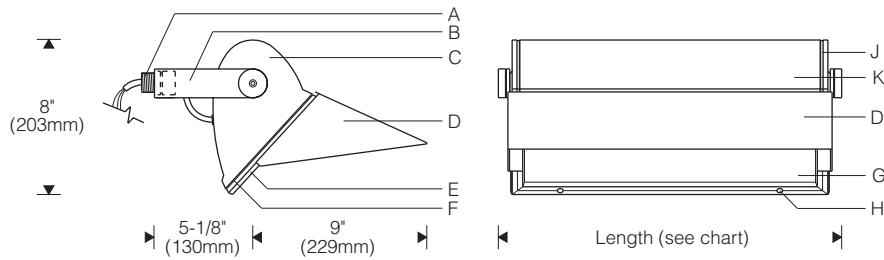

Wattage	Source	Length
150	MH	12-1/16" (306mm)
300-500	Halogen	17-13/16** (452mm)
210-400	MH	24-7/8** (632mm)
900, 1000	Halogen	24-7/8** (632mm)
2x400	MH	

\*Yoke includes (2) 9/32" diameter holes at 12" (305mm) centers for supplemental mounting support (1/4" fasteners by others).



**Slipfitter: Single Unit** 1:10 Scale (For use with X Mount)

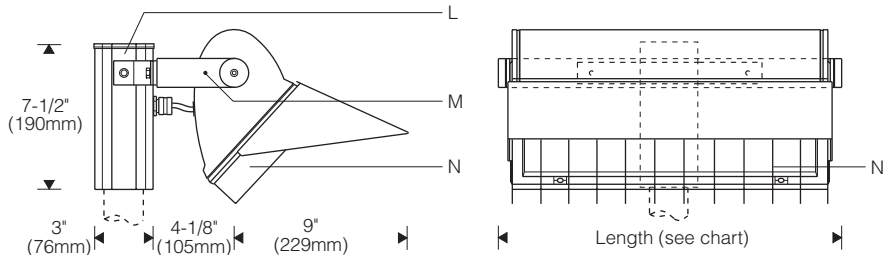

**Slipfitter: Double** 1:16 Scale

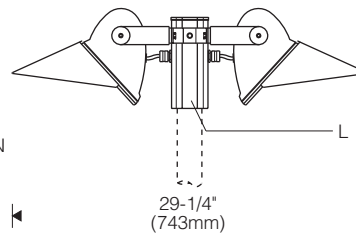

**Specifications**

- A** 1/2" NPT nipple
- B** Aluminum yoke with locking set screw
- C** Die-cast aluminum end plates
- D** Cutoff visor (included)
- E** Mitred extruded aluminum door frame
- F** Precured silicone door and lens gasket
- G** Clear, flat, thermal and impact resistant tempered glass lens
- H** Tamper-resistant captive door screws
- J** Aluminum reveal plates (black)
- K** Specular extruded aluminum reflector
- L** Accessory extruded aluminum slipfitter for 2-3/8" O.D. tenon or pole
- M** Locking set screw
- N** Accessory vertical blade cross baffle (black)

**Finish:**

Exterior surfaces – 6 stage pretreatment and electrostatically applied thermoset polyester powder coating for a durable abrasion, fade and corrosion resistant finish. Choice of semi-gloss colors (see ordering information).

Reflector and internal end plates – extruded high purity aluminum with clear anodized specular finish. All hardware and components – non-corrosive stainless steel or aluminum. Door secured with captive tamper-resistant (#10 Torx) screws in stainless steel threaded reflector inserts to prevent seizing. Yoke attaches with recessed hex socket screws.

**Mounting:**

1/2" NPT nipple (wet location outlet box and outlet box cover or fitting by others).

Accessory slipfitter (ordered separately) for 2-3/8" O.D. pole, tenon or stanchion (by others). Side-mount for single or double (back-to-back) units, specify **X** mount.

**Electrical:**

Use 90°C wire for supply connections. Leads exit reflector through watertight flush cord entry, silicone coated fiberglass sleeving; 8" exposed beyond nipple (60" leads on **X** mount).

Tungsten halogen – recessed single contact (RSC) lampholders in patented clamping supports for maximum heat dissipation.

Metal halide – Mogul lampholder is pulse rated for use with either horizontal or universal position reduced envelope pulse start lamps. End-of-lamp aligner ensures consistent optical performance, minimizes damage from shock or vibration. Ballast – remote HPF constant wattage autotransformer (CWA) or electronic rated for -20°F/-29°C starting. Weatherproof aluminum enclosure includes three 7/8" dia. entries and one 3/8" liquidtight conduit connector. Optional remote ballast for dry indoor location.

For complete ballast specifications, see Accessories Section.

**Standard:**

UL listed or CSA certified for wet locations.

**Features**

- Maximum peak candlepower for broad uniform coverage – controlled distribution minimizes "spill" or trespass light
- Compact yet powerful – up to 1000W halogen, 2x400W MH
- Lamp support on mogul base lamps ensures arc tube is in optical center
- Built to last – all aluminum and stainless steel components

**Performance**

Two parabolic reflector sections drive light across the ground plane from one edge. An elliptical section redirects its light to a parabola and shields the lamp. Asymmetry is maximized resulting in high beam efficiency and superior surface uniformity. Fast "runback" minimizes wasted spill and trespass light. Wide lateral distribution permits greater spacings.

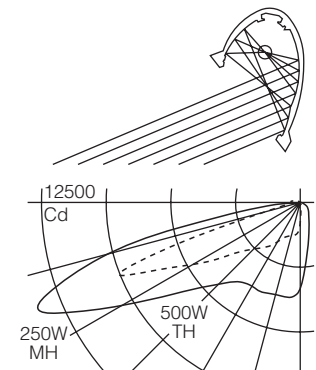

For complete photometrics, visit [thelightingquotient.com](http://thelightingquotient.com)



To form a Catalog Number

1 5 2 | - | - | - V | | |  
 1 2 3 4 5 6 7 8

1 Source

M = Metal halide  
 T = Tungsten halogen

2 Style



152 = Large outdoor, remote ballast

3 Lamp

Lamp Code	Wattage	Lamp Number	Voltages	Remote Distance
-----------	---------	-------------	----------	-----------------

Ceramic Arc Tube Pulse Start Metal Halide (90+ CRI) 

210C	210	CDM210/T9/930/U/E	2, U	30' (9m)
315C	315	CDM315/T9/930/U/E	2, U	30' (9m)

Ceramic Arc Tube Pulse Start Metal Halide (80+ CRI)\*  

150G	150	CDM150/T6/830	1, 2 T, U	15' (4.5m) 5' (1.5m)
250C	250	CMH250/U/830/R	A, B	50' (15m)
400C	400	CMH400/U/830/R	A, B	50' (15m)
240C	2x400	(2) CMH400/U/830/R	A, B	50' (15m)

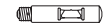
Quartz Arc Tube Pulse Start Metal Halide (68 CRI)\* 

250P	250	MS 250W/H75/T15/PS/740	A, B 2, U	50' (15m) 16' (4.8m)
320P	320	MS 320W/H75/T15/S/PS/740	A, B 2, U	50' (15m) 16' (4.8m)
350P	350	MS 350W/H75/T15/PS/740	A, B 2, U	50' (15m) 16' (4.8m)

Tungsten Halogen 

0300	300	Q300T3	A	
0350	350	Q350T3/CL/HIR	A	
0500	500	Q500T3	A	
0900	900	Q900T3/CL/HIR	B, G	
1000	1000	Q1000T3	F, G	

For complete lamp and ballast information, see Accessories Section.  
 \* Use only clear metal halide horizontal or universal position lamp with compact envelope. Standard lamp colors are 3000K for Ceramic Arc Tube Pulse Start lamps and 4000K for Quartz Arc Tube Pulse Metal Halide lamps.

Project: \_\_\_\_\_

4 Mounting

V = External yoke with 1/2" NPT nipple (wet location outlet box and outlet box cover or fitting by others)  
 X = External yoke for use with accessory side-mount slipfitter (order separately)

5 Finish

02 = Semi-gloss white  
 06 = Dark bronze  
 07 = Silver  
 08 = Semi-gloss black  
 12 = Green  
 99 = Custom RAL or computer matched color to be specified, consult sales representative.

6 Voltage/Ballast

Electronic (Metal Halide only):  
 1 = 120V  
 2 = 277V  
 T = 120V dim\*  
 U = 208-277V dim\*  
 Magnetic and Tungsten Halogen:  
 A = 120V  
 B = 277V  
 F = 220V (TH)  
 G = 240V (TH)

\*100-50% dimming, 0-10V compatible controls by others. Consult factory for dimming the 210W lamp.

7 Option (see Accessories Section for specifications)

V0 = No options  
 VL = Micro-prismatic tempered glass lens (replaces clear, flat lens), offers smoother light pattern at reduced peak candlepower.  
 VR = Halogen standby lamp with relay field connected at remote ballast. 100W maximum (lamp included). Not available for 2x400W.  
 VS = X mount for use with slipfitter on pole higher than 8' (2.4m). Supplied with 30' (9m) wire leads. For use with MH units only (except 150W or dimming).  
 VX = For modification not listed, include detailed description. Consult factory prior to specification.

Note: Cutoff visor included unless specified otherwise.

8 Destination Requirement

0 = UL listed or CSA certified for U.S.  
 J = UL listed or CSA certified for Canada

Example

M152 - 250C - V - 07 - B - V00

Large outdoor model for use with 250 watt ceramic arc tube pulse start metal halide lamp. External yoke with 1/2" NPT nipple. Silver powder coat finish. Remote 277V ballast in weatherproof enclosure. UL listed or CSA certified for U.S. Cutoff visor included.

Type: \_\_\_\_\_

Accessories

Order separately. See Accessories Section for specifications.

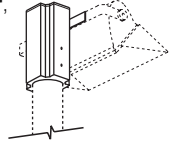
ASF | S | 0 = Side-mount slipfitter, for 2-3/8" O.D. pole, tenon or stanchion (for use with X mount units)  
 1 = single unit  
 2 = double unit (back to back)  
 5 Finish 

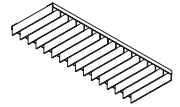
AE | V | 0D0 = External vertical blade baffle, black, for lengthwise shielding  
 2 = 25° shielding  
 4 = 45°  
 C = 300W, 350W TH; 150W MH (not for use with 500W TH units)  
 D = 210W-400W MH  
 F = 900W, 1000W TH; 2x400W MH 

AFK000X | = Ballast fuse kit  
 0 = U.S.  
 J = Canada 